

Model No.HS009G 235MM CORDLESS CIRCULAR SAW

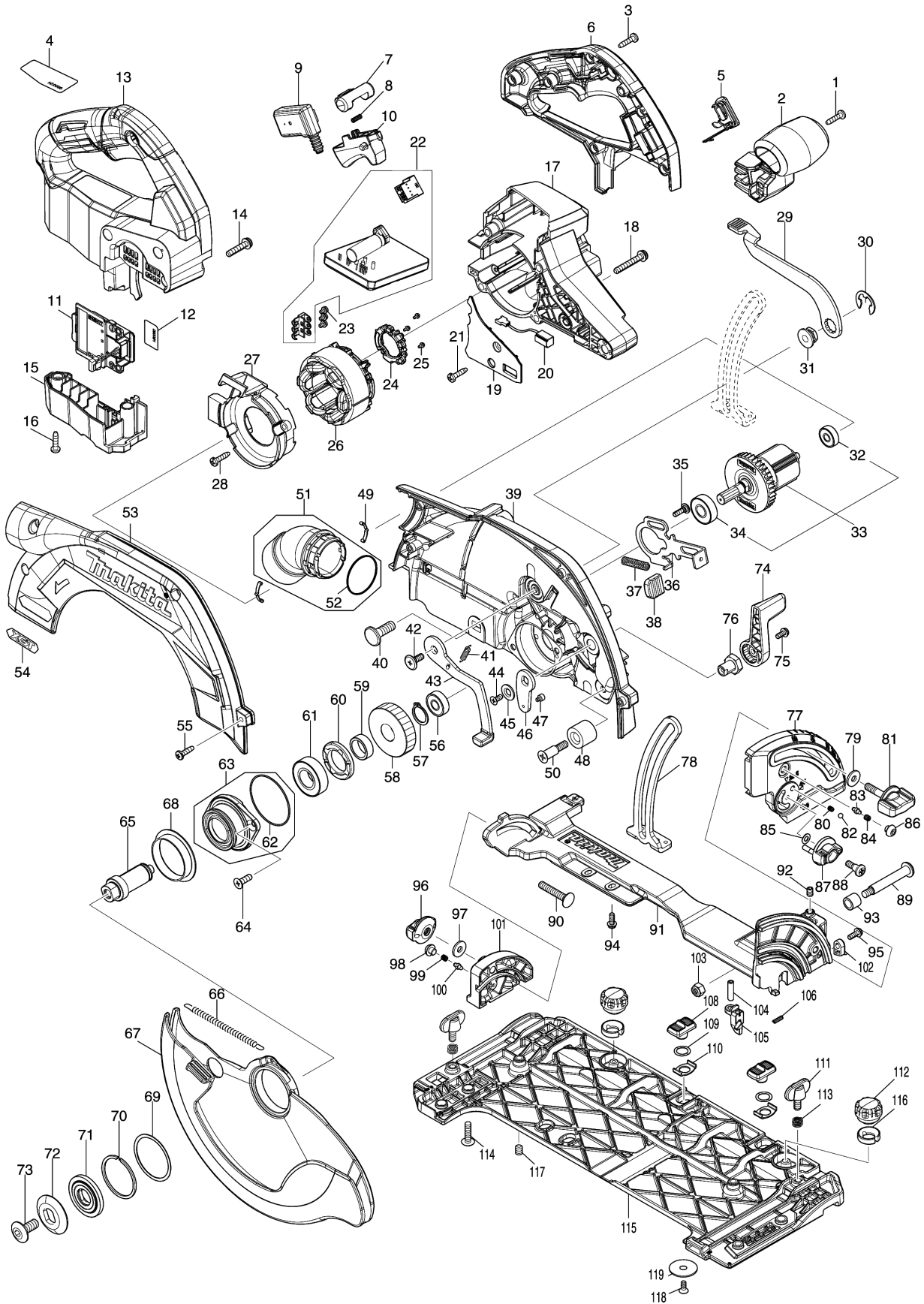

Model No.HS009G 235MM CORDLESS CIRCULAR SAW

Položaj	Številka dela	Opis	Sprememba	Količina	New/Old	Opcijsko 1	Opcijsko 2	Opomba
001	266326-2	Pločevinasti vijak 4x18 UB1103		1				
002	413C21-5	FRONT GRIP		1				
003	266326-2	Pločevinasti vijak 4x18 UB1103		6				
004	8114P0-9	HS009G NAME PLATE		1				
005	140F99-0	CAP COMPLETE		1				
C10	213A05-9	O-RING16		1				
006	183U47-6	HANDLE SET		1				
C10	263005-3	Gumi zatič 6		1				
D10		INC. 13						
007	419704-7	Gumb za izklop orodja KP0810		1				
008	231433-0	Tlačna spiralna vzmet 4		1				
009	650008-0	SWITCH C3XB-1LPSPM		1				
010	413C24-9	SWITCH LEVER		1				
011	632P65-6	TERMINAL UNIT		1				
012	8114P6-7	HS009G SERIAL NO. LABEL		1				
013	183U47-6	HANDLE SET		1				
C10	263005-3	Gumi zatič 6		1				
D10		INC. 6						
014	911243-8	Vijak z nizko cilindrično glavo M5X25		3				
015	141G16-9	TERMINAL HOUSING COMPLETE		1				
C10	263005-3	Gumi zatič 6		1				
016	266326-2	Pločevinasti vijak 4x18 UB1103		2				
017	413C17-6	MOTOR HOUSING		1				
018	911258-5	Vijak z nizko cilindrično glavo M5x35		4				
019	413C23-1	LIGHT COVER		1				
020	620936-3	LED CIRCUIT		1				
021	266326-2	Pločevinasti vijak 4x18 UB1103		1				
022	620H80-4	CONTROLLER		1				
023	652069-6	FLAT HEAD SCREW M3X6		3				
024	632R96-7	SENSOR UNIT		1				
025	652093-9	PAN HEAD SCREW M2X5		3				
026	629A40-1	STATOR		1				
027	413C22-3	BAFFLE PLATE		1				
028	266326-2	Pločevinasti vijak 4x18 UB1103		2				
029	271453-2	LEVER 132		1				
030	257953-6	Seger obroč E-12		1				
031	252262-8	COLLERED HEX. NUT M8		1				
032	210022-4	Kroglični ležaj 626DDW 9526NB		1				

Model No.HS009G 235MM CORDLESS CIRCULAR SAW

Položaj	Številka dela	Opis	Sprememba	Količina	New/Old	Opcijsko 1	Opcijsko 2	Opomba
033	519721-8	ROTOR ASS'Y		1				
D10		INC. 32,34						
034	210059-1	Kroglični ležaj 6000DDW GA9050		1				
035	251529-1	+ PAN HEAD SCREW M4X14		1				
036	347676-5	SHAFT LOCK		1				
037	233084-5	Tlačna spiralna vzmet 6		1				
038	286039-9	CAP		1				
039	141G17-7	BLADE CASE COMPLETE		1				
C10	213434-0	O tesnilo 26		1				
C20	263005-3	Gumi zatič 6		1				
C30	8004T1-0	SCALE LABEL		1				
040	266396-1	Vijak z ravno glavo M8		1				
041	232563-0	TENSION SPRING 4		1				
042	265A60-7	+ PAN HEAD SCREW M5X14		1				
043	162686-9	OPEN LEVER		1				
044	265135-6	+ COUNTERSUNK HEAD SCREW M4X10		1				
045	347577-7	WASHER 6		1				
046	347576-9	OPEN PLATE		1				
047	265A82-7	HEX. SOCKET HEAD SCREW M3X4		1				
048	262185-2	RUBBER SLEEVE8		1				
049	232674-1	LEAF SPRING		2				
050	251572-0	+ COUNTERSUNK HEAD SCREW M6X30		1				
051	136173-4	DUST NOZZLE ASS'Y		1				
D10		INC. 52						
052	213444-7	O RING 30		1				
053	312C12-2	BLADE CASE COVER		1				
054	8032A7-2	XGT LOGO LABEL		1				
055	266034-5	Pločevinasti vijak 5604R		4				
056	210029-0	Kroglični ležaj 608ZZ GA7050		1				
057	961057-5	Zaščitni obroč S-17		1				
058	226934-1	HELICAL GEAR 46		1				
059	257451-0	RING 17		1				
060	285809-3	Podpora za kroglični ležaj 23-36		1				
061	210301-0	Kroglični ležaj 6003DDW		1				
062	213623-7	O-Tesnilo 46 LF1000		1				
063	136192-0	BEARING BOX ASS'Y		1				
D10		INC. 62						
064	265034-2	Vijak z vgreznjeno glavo M5x16		2				

Model No.HS009G 235MM CORDLESS CIRCULAR SAW

Položaj	Številka dela	Opis	Sprememba	Količina	New/Old	Opcijsko 1	Opcijsko 2	Opomba
065	327192-3	SPINDLE		1				
066	232562-2	TENSION SPRING 6		1				
067	312C14-8	SAFETY COVER		1				
068	459830-0	SPACER		1				
069	267337-0	Ploska podložka 40		1				
070	257452-8	RETAINING RING (EXT) WR-40		1				
071	224360-8	INNER FLANGE 40		1				
072	224600-4	OUTER FLANGE 38		1				
073	265A59-2	HEX.SOCKET HEAD BOLT M8		1				
074	271451-6	LEVER 55		1				
075	911113-1	Vijak z nizko cilindrično glavo M4x10		1				
076	252275-9	HEX. NUT M4-16		1				
077	312C17-2	FRONT ANGULAR PLATE		1				
078	347574-3	DEPTH GUIDE		1				
079	253111-2	Ploska kovinska podložka 6		1				
080	233314-4	Tlačna spiralna vzmet 4 5007MG		1				
081	265776-8	Krilni vijak M6x26		1				
082	216008-6	Kovinska kroglica 4 mm		1				
083	263041-9	SHOULDER PIN 3-5		1				
084	231234-6	Tlačna spiralna vzmet 3.5		1				
085	253811-4	Ploska podložka 5		1				
086	266559-9	H.S.BUTTON HEAD BOLT M6X4		1				
087	450704-8	DIAL 27		1				
088	251370-2	Vijak z nizko cilindrično glavo M5		1				
089	251528-3	+ PAN HEAD SCREW M6		1				
090	266332-7	R.H SQUARE NECK BOLT M6X35		1				
091	141G18-5	FRAME COMPLETE		1				
092	266229-0	Inbus vijak M5x8 5007MG		1				
093	257580-9	SLEEVE 8		1				
094	265A84-3	PAN HEAD SCREW M4X12 WITH WR		2				
095	911118-1	Vijak z nizko cilindrično glavo M4x12		1				
096	252270-9	THUMB NUT M6		1				
097	253111-2	Ploska kovinska podložka 6		1				
098	266559-9	H.S.BUTTON HEAD BOLT M6X4		1				
099	231234-6	Tlačna spiralna vzmet 3.5		1				
100	263041-9	SHOULDER PIN 3-5		1				
101	312C18-0	REAR ANGULAR PLATE		1				
102	419632-6	POSITION PLATE SP6000		1				

Model No.HS009G 235MM CORDLESS CIRCULAR SAW

Položaj	Številka dela	Opis	Sprememba	Količina	New/Old	Opcijsko 1	Opcijsko 2	Opomba
103	252014-7	Šesterokotna matica M6-10 N9500B		1				
104	265A83-5	H.S.SET SCREW(FLAT POINT)M5X20		1				
105	412210-1	SLIDER		1				
106	233025-1	Tlačna spiralna vzmet 2		1				
108	458092-7	SLIDE LEVER		2				
109	253932-2	Valovita podložka 10		2				
110	345977-5	PLATE		2				
111	265701-9	Zatezni vijak M6x14		2				
112	265775-0	Krilni vijak M4x3		2				
113	233376-2	Tlačna spiralna vzmet 8 9558NB		2				
114	265181-9	+TRUSS HEAD SCREW M5X20		4				
115	312C15-6	BASE		1				
116	419627-9	Držalo SP6000		2				
117	266225-8	HEX.SOCKET HEAD SCREW M6X8		2				
118	912112-6	Vijak z vgreznjeno glavo M4x10		2				
119	345748-0	LOCK WASHER		2				
A01	162687-7	SUB BASE		1				
A02	E-01909	TCT BLADE 235X24T WOOD EFFICUT		1				
A03	783204-6	Inbus ključ 6 DA4031		1				
A04B	***DC40RA	DC40RA FAST CHARGER		1				
D10		COMPO-PARTS						
A05B	821866-3	PLASTIC CARRYING CASE		1				
C10	162271-8	Zapiralo za plastični kovček		2				
C20	453229-1	THUMB SCREW M12X8		1				
A06B	412393-7	BATTERY COVER		2				
A07B	191L47-8	BATTERY BL4050F SET		2				

Please order the parts with part number.

Print Date 25/2/2022